



---

GENESIS  
Electrified G80  
EMERGENCY RESCUE  
MANUAL

---

# Contents

---

<b>1. Identification / recognition</b>	<b>1</b>
<b>2. Immobilization / stabilization / lifting</b>	<b>3</b>
<b>3. Disable direct hazards / safety regulations</b>	<b>5</b>
<b>4. Access to the occupants</b>	<b>9</b>
<b>5. Stored energy / liquid / gases / solids</b>	<b>12</b>
<b>6. In case of fire</b>	<b>15</b>
<b>7. In case of submersion</b>	<b>19</b>
<b>8. Towing / transportation / storage</b>	<b>20</b>
<b>9. Important additional information</b>	<b>23</b>

## **Initial Response: Identify, Immobilize and Disable**

The following procedures should be used whenever you are dealing with an Electrified G80 at an emergency scene. However, all operations should be consistent with your department's standard operating procedures, guidelines, and any applicable laws. When an EV is damaged in a crash, the high voltage safety systems may have been compromised and present a potential high voltage electrical shock hazard. Exercise caution and wear appropriate personal protective equipment (PPE) safety gear, including high voltage safety gloves and boots. Remove all metallic jewelry, including watches and rings.

### **Identify**

The Electrified G80 is an electric vehicle. Emergency responders should respond to emergency scenarios involving the Electrified G80 accordingly, exercising extreme care and caution to avoid contact with the high voltage system within the vehicle.

## General Vehicle Description

The safest method is to assume that Electrified G80 you respond to is an electric vehicle. Using the information provided in this section, responders will be able to differentiate between the two.

## Identifying an Electrified G80



Charge Port

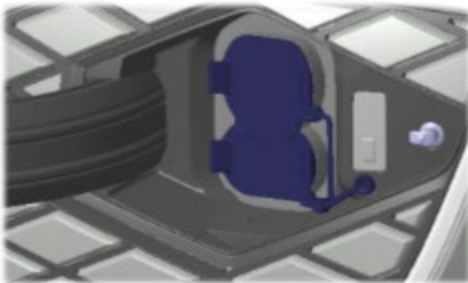

Charge Port (W/o Cap)



## 2. Immobilization / stabilization / lifting

3

### Immobilize

The next step is to immobilize the vehicle to prevent any accidental movement that can endanger the emergency response personnel and any crash victims. Since the Electrified G80 doesn't have an engine, there will be instances where the vehicle appears to be off because of the absence of engine noise. When in its "ready" mode, the vehicle can move almost silently using the electric motor. Responders should approach the vehicle from the sides and stay away from the front or rear as they are both potential paths of travel. Instructions for immobilizing the vehicle are shown below.

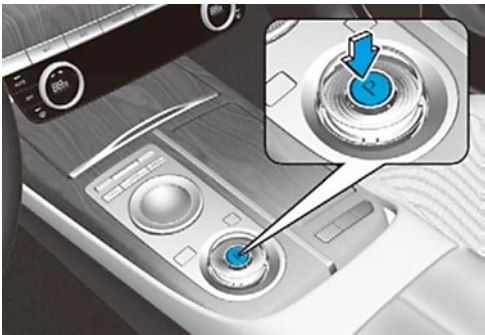

1. Step on the brake pedal to park the vehicle stably. Then select (push) 'P' button on the shift selector



2. Engage Parking Brake



3. Press the "POWER" START/STOP Button



4. Chock the Wheels

\* The actual image of vehicle may differ from the illustration

## 2. Immobilization / stabilization / lifting

4

### Extrication Operations

The extrication operations for the Electrified G80 are similar to a conventional vehicle. However, the first responder should pay special attention when they extract occupants in the vehicle. Before extrication operations, the first responders should carry out “Initial Response: Identify, Immobilize and Disable” procedure section in page 5 to 8.

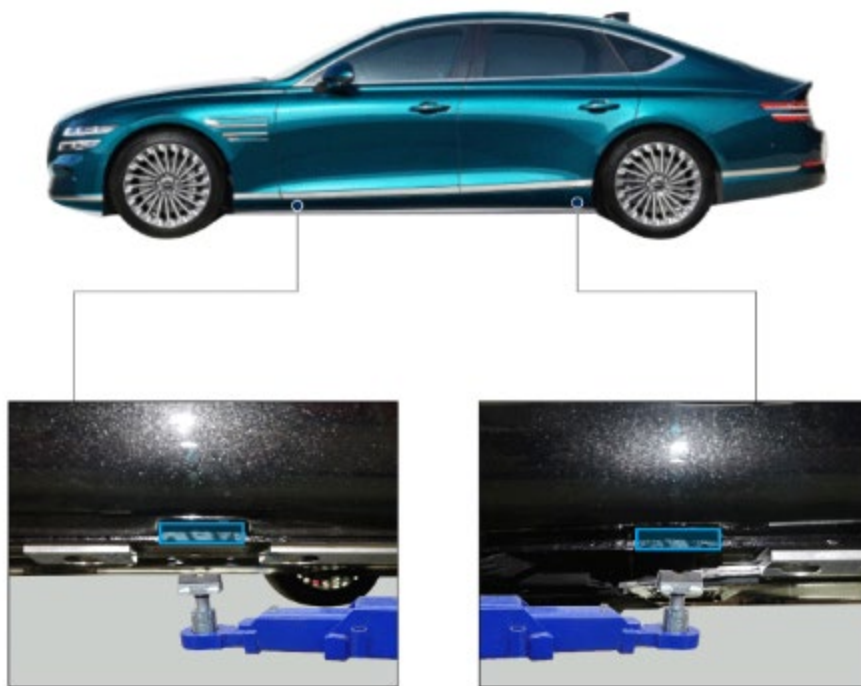

\* The actual image of vehicle may differ from the illustration

### Vehicle Stabilization

Use standard stabilization (cribbing) points, as shown. Always be sure to connect to a structural member of the vehicle and avoid placing cribbing under high voltage cables, fuel lines and other areas not normally considered acceptable.

## 3. Disable direct hazards / safety regulations

5

The final step in the initial response process, conducted after immobilizing the vehicle, is to disable the vehicle, its SRS components and the high voltage electrical system. To prevent current flow through the system, use the following procedure to disable the vehicle.

### 3.1 Disabling the System – Smart Key System and “POWER”

#### START/STOP Button

1. Confirm the status of the READY light on the instrument panel. If the READY light is illuminated, the vehicle is ON.
  - a) If the READY light is NOT illuminated, the vehicle is off. Do not push the “POWER” START/STOP button because the vehicle may start (go into READY mode).
  - b) To turn OFF the system, press the 'P' button, and press the POWER button.



“EV” START/STOP Button

#### Without depressing the brake pedal

Pressing POWER button	Button Position/LED	Vehicle condition
One time	ACC/ON	Electrical accessories are operational.
Two times	ON/ON	The warning lights can be checked before the vehicle is started.
Three times	OFF	Off

#### While depressing the brake pedal

Pressing POWER button	Button Position/LED	Vehicle condition
One time	–	Ready to drive

### 3. Disable direct hazards / safety regulations

2. Before disconnecting the 12V battery, remove the Smart Key at least 2 meters away from the vehicle to prevent accidental restart.



SMART KEY

3. Disconnect the negative (-) 12V battery cable located in the rear cargo area, following the procedures to further prevent the risk of accidental restart.

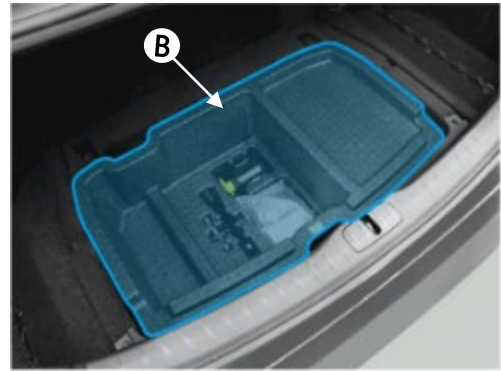

#### NOTICE

If necessary, lower the windows, unlock the doors and open the tail gate as required, before disconnecting the 12V battery. Once the 12V battery is disconnected, power controls will not operate.



### 3. Disable direct hazards / safety regulations

7

4. Disconnect the High voltage cut-off switch.
5. Remove the High voltage cut-off Switch located in the low voltage junction block.
  - a) Remove the Junction block upper cover "A" in the PE (Power Electric) room, located under the front hood.



- b) Disconnect the High voltage cut-off Switch "B" using the following procedure :

① : Pull the label → ② : Disconnect

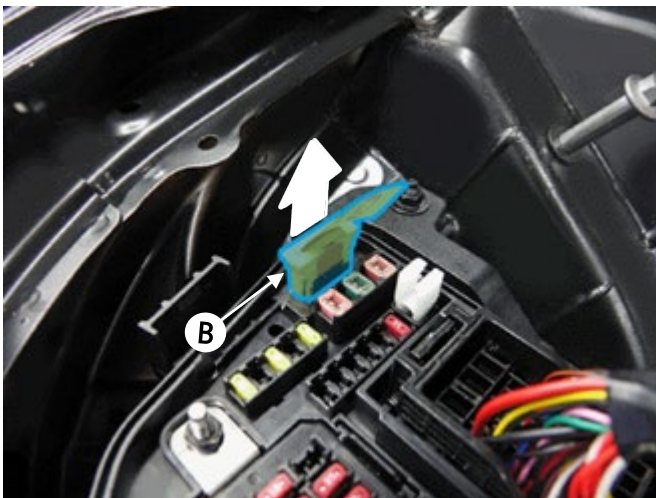

**B : High voltage cut-off Switch**

## 3. Disable direct hazards / safety regulations

8

### **⚠ WARNING** Electrocutation Risk

- Before engaging in any emergency response procedures, ensure the vehicle is disabled and wait 5 minutes to allow the capacitor in the high voltage system to discharge to avoid electrocution.
- Exposed cables or wires may be visible inside or outside the vehicle. Never touch the metal chassis wires, cables, connectors, or any electric components before disabling the system, and/or shorted to the vehicle chassis.

Failure to follow these instructions will lead to serious bodily injury or death by electrocution.

## 4. Access to the occupants

### 4.1 Extraction Operations

The Electrified G80 is an electric model. Because of the high voltage components contained, first responders should pay special attention when they extract occupants in the car. Before performing any extraction operations, the first responders should "Identify, Immobilize and Disable" the vehicle as discussed in sections on emergency procedures.

### 4.2 Vehicle Stabilization

Use standard stabilization (lift) points, as shown beside. Always be sure to connect to structural member of the vehicle and avoid placing cribbing under high voltage cables, and other areas not normally considered acceptable.

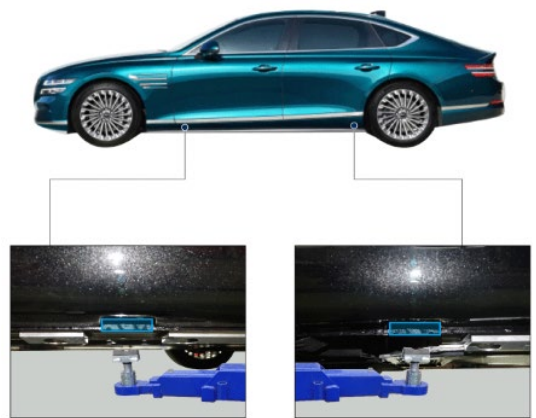

### 4.3 How to open the door manually



### 4.4 Extraction tools and procedure

When responding to an incident involving an Electrified G80, we recommend that the first responders follow their organization's standard operating procedures for dealing with vehicle emergencies.

When the first responders cut the vehicle, they should always pay special attention to the airbag system, orange colored high voltage cables and other high voltage components so that the parts are not damaged and to prevent a risk of explosion.





## 4. Access to the occupants

10

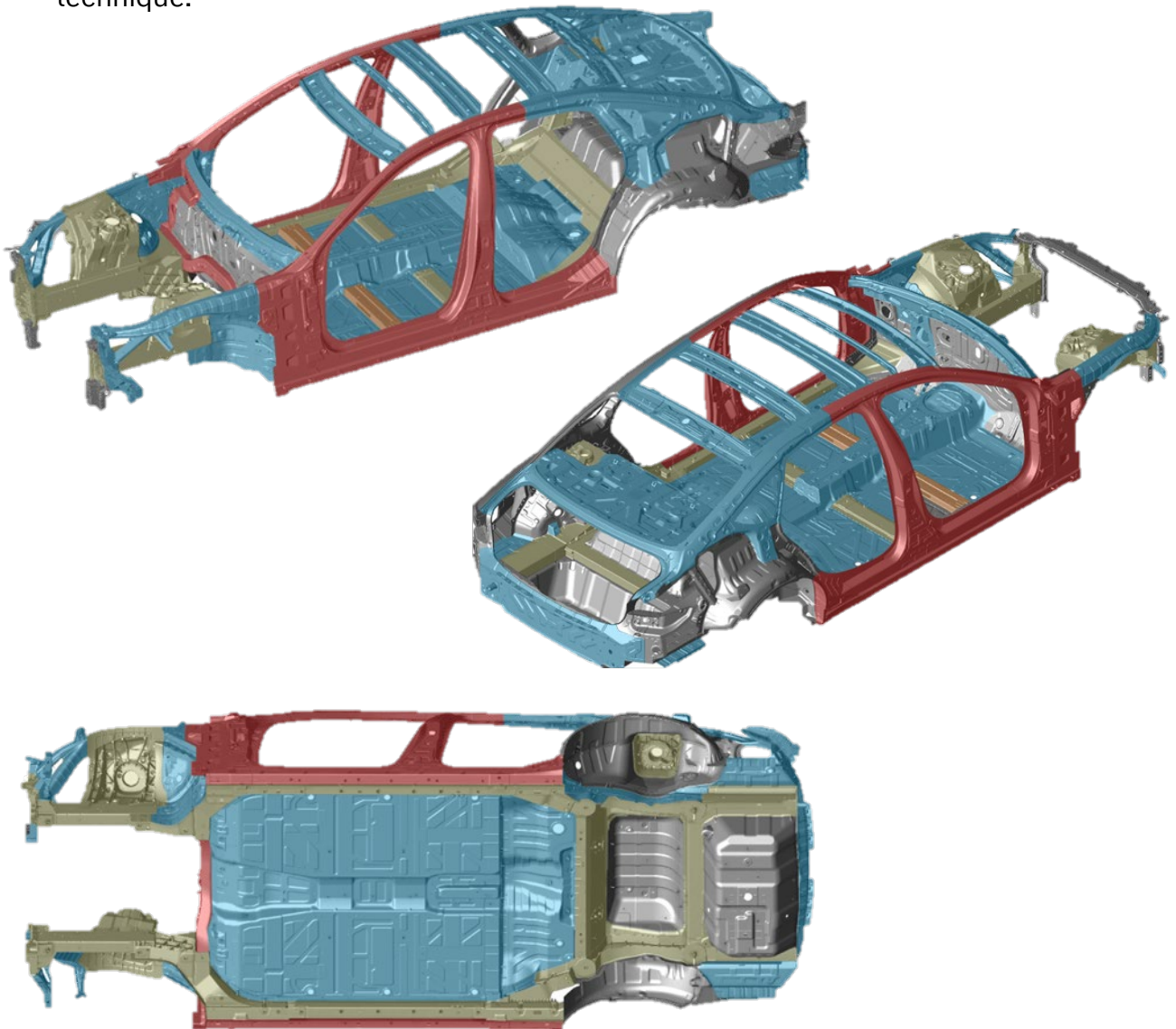
### 4.5 Location of ultra-high strength steel

In these images, high strength steel is used in the areas colored in blue and ultra-high strength steel is used in the red colored areas. Depending on the tools used, ultra high strength steel can be challenging or impossible to cut. If necessary, use a workaround technique.

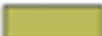









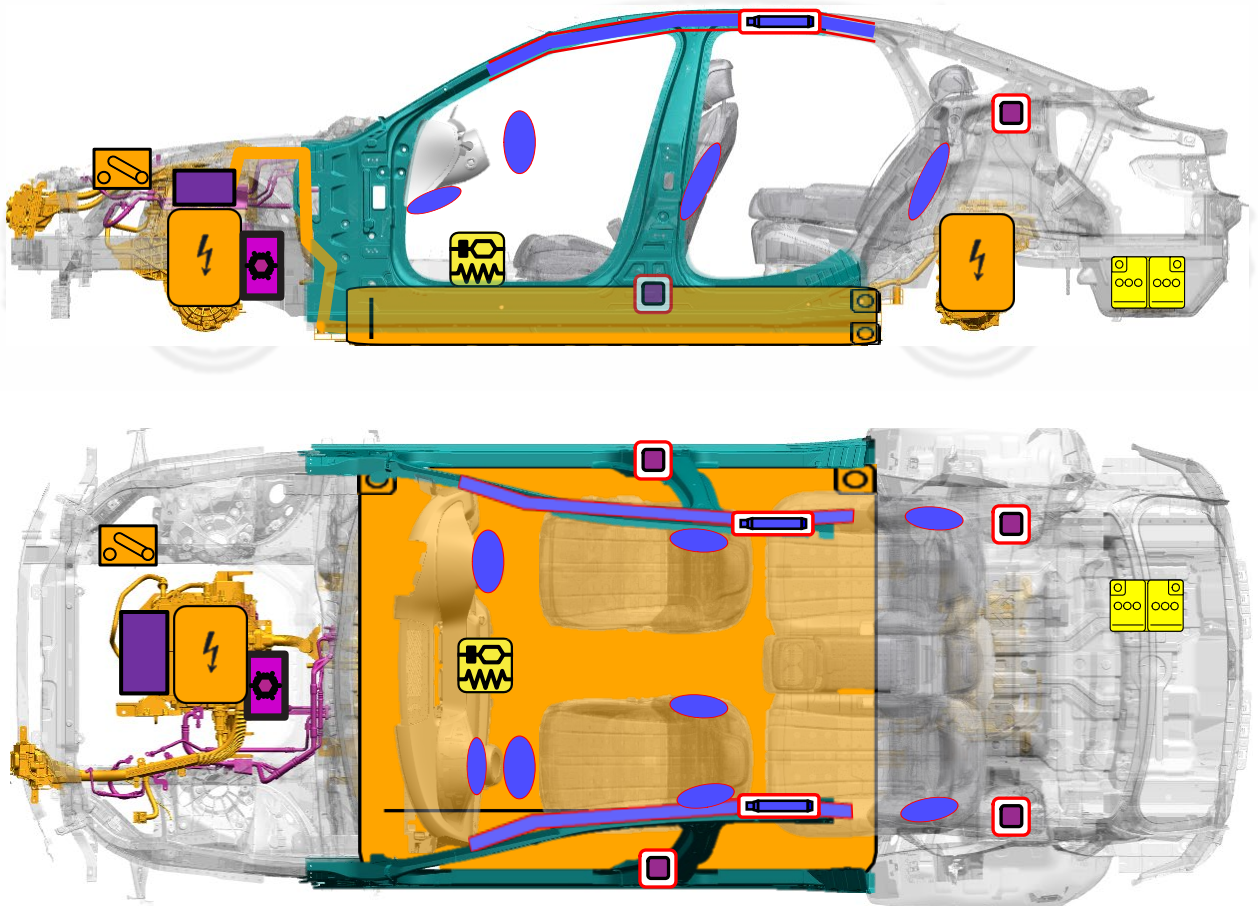





-  Mild steel
-  High strength steel
-  Ultra-high strength steel
-  Aluminum alloy
-  Carbon fiber reinforced plastic

## 4. Access to the occupants

### 4.5 Location of ultra-high strength steel

When dealing with an emergency situation, check the components as below.



 Supplemental Restraint System Control Module (SRSCM)	 Airbag	 Airbag Gas Inflators
 High voltage cable	 12V Battery	 Air-conditioning line
 High voltage disconnect	 OBC (On - Board Charger)	 Ultra-High Strength Steel
 High Voltage Battery	 Air-conditioning component	 Seat belt pretensioner
 Motor Drive Unit		

## 5. Stored energy / liquid / gases / solids

12

### 5.1 High voltage system

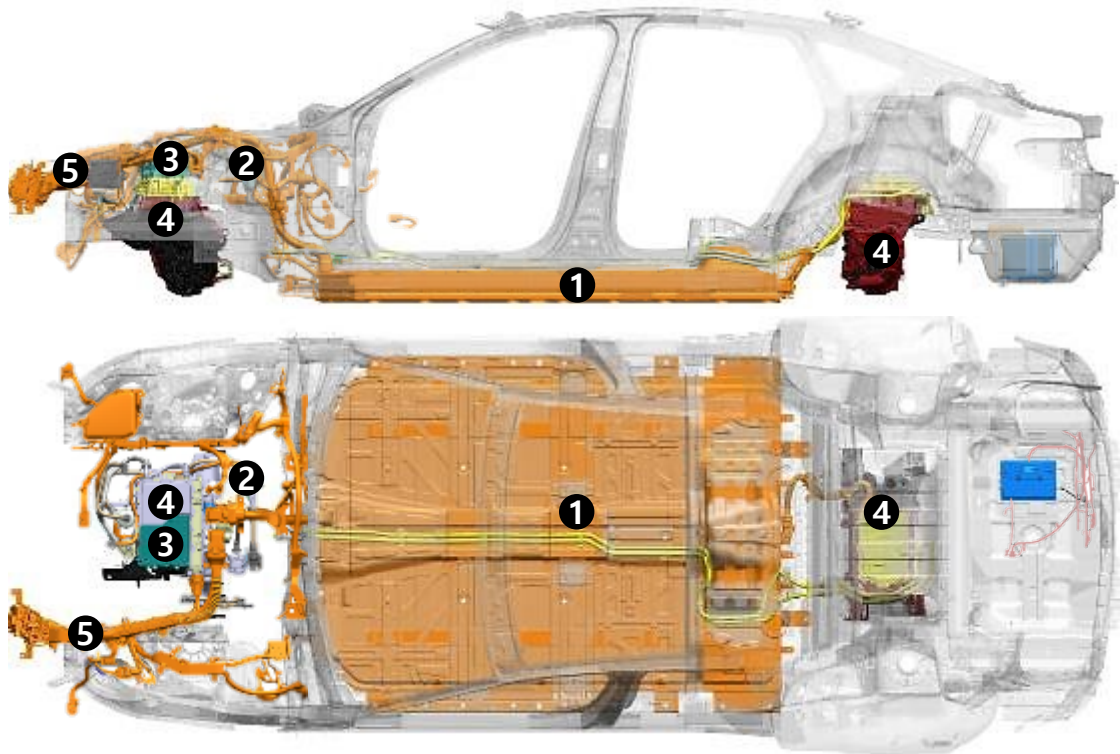

1	<b>High voltage battery</b>		Supplies electric energy to traction motor and stores generated electric energy.
2	<b>High-voltage Junction box</b>		It supplies electricity from battery to the inverter, LDC, air conditioner compressor, etc...
3	<b>ICCU (OBC + LDC)</b>		Integrated Charging Control Unit (OBC + LDC) OBC (On-Board Charger) : Battery charging equipment (AC→DC) LDC (Low Voltage DC-DC Converter) : Charge 12V auxiliary battery
4	<b>Drive System</b>	<b>Motor</b>	When current flows through the coil, it generates a rotating magnetic field and generates motor torque.
		<b>EV Transmission</b>	Increases Motor Torque and increased Torque is transferred to the wheels.
		<b>Inverter</b>	DC → AC (from battery to traction motor) AC → DC (charge using regenerative braking)
5	<b>High-Voltage Cable</b>		The high-voltage cabling is orange per the SAE standard.

## 5. Stored energy / liquid / gases / solids

13

### 5.1 High voltage system

#### High voltage battery

The High Voltage Lithium-ion battery supplies and stores electric energy, to the traction motor, and is located under the Electrified G80 chassis.



#### 12V auxiliary battery

The 12V auxiliary battery is at the right side of the rear cargo area, and powers all the vehicle's standard electronics like radio, lights, door locks, power windows, etc.

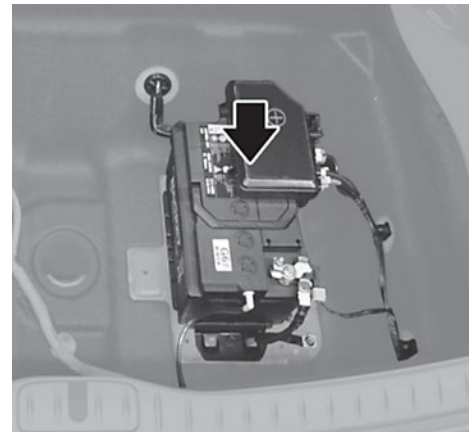

### ※ Specification

<b>Motor</b>	Type	Permanent magnet synchronous motor
	Max. Output (kW)	4WD : 160+160
	Max Torque (Nm)	4WD : 350+350
<b>ICCU (LDC)</b>	Max. Output (kW)	2.1
<b>High Voltage Battery</b>	Type	Lithium-ion
	Rated Voltage (V)	522.7
	Energy (kWh)	87.2
	Quantity for Pack (Cell / Module)	384 cells / 36 modules

### 5.2 High voltage orange cabling

The High Voltage cabling is orange, per Society of Automotive Engineers (SAE) standards. Cables run under the floor of the vehicle and connect the High Voltage Battery to the ICCU, Motor, OBC, A/C compressor and other High Voltage components located towards the front and rear of the vehicle.

The presence of orange cables under the hood, in the under-floor battery compartment or HV cables under the car, identifies the vehicle as an electric vehicle.

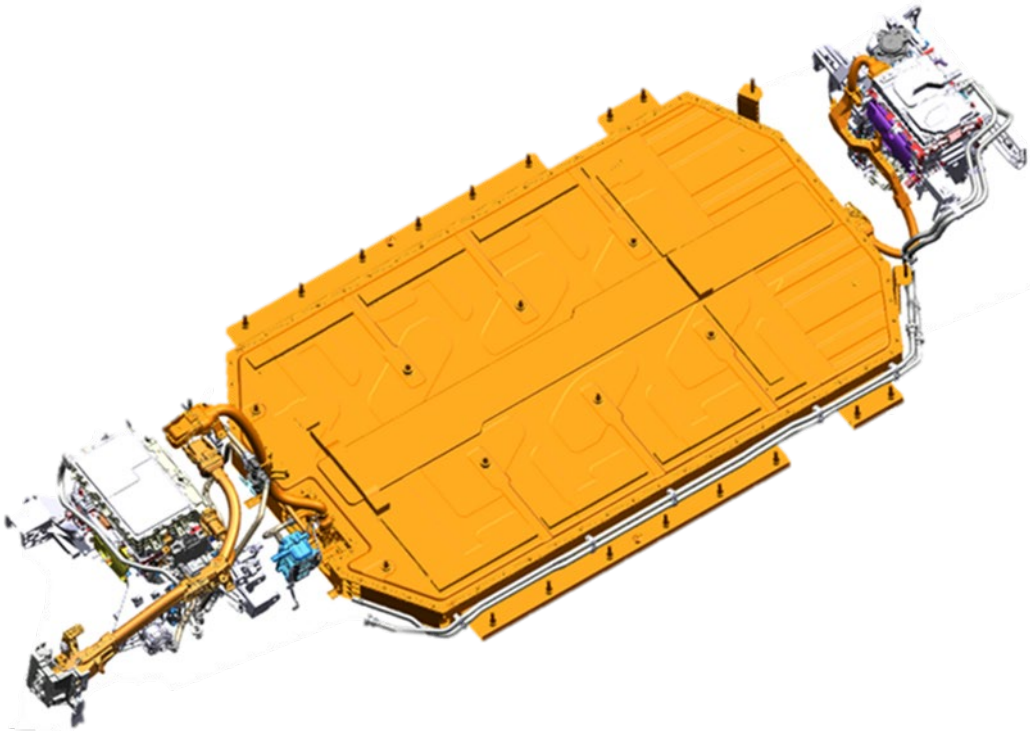

#### **⚠ WARNING** Electrocutation Risk

- Never cut or disconnect the high voltage orange cabling and connectors without first disabling the HV system. (refer to page 7 ).
- Exposed cables or wires may be visible inside or outside the vehicle. Never touch the metal chassis wires, cables, connectors, or any electric components before disabling the system, and; or shorted to the vehicle chassis.

Failure to follow these instructions will lead to serious bodily injury or death by electrical shock.



### 6.1 Firefighting Operations

Strict precautions must be taken while conducting firefighting operations due to following Reasons:

- Lithium-ion batteries contain electrolyte that can vent, ignite, and produce sparks when subjected to temperatures above 300°F.
- Vehicle may burn rapidly with a flare-burning effect.
- Even after the high-voltage battery fire appears to have been extinguished, renewed or delayed fire can occur.
  - Use a thermal imaging camera to ensure the high voltage battery is completely cooled before leaving the incident.
  - Always advise second responders that there is a risk of the battery re-igniting.
  - In a fire, submersion or a collision that has compromised the high voltage battery, always store it in an open area with no exposures within 50 feet.
- A burning battery could release hydrogen fluoride, carbon monoxide, and carbon dioxide gasses. Use NIOSH/MSHA approved full-face self-contained breathing apparatus (SCBA) with full protective gear. Even if the high-voltage battery pack is not directly involved in a vehicle fire, approach the vehicle very carefully.

### 6.2 Extinguishers

- Small fires that do not involve the high voltage battery should be extinguished using an ABC fire extinguisher. (ex. Fire caused by wiring harnesses, electrical components, etc.)
- Do not attempt to extinguish fires that involve the high voltage battery with small amounts of water as this can result in electrocution. Fires that involve the high voltage battery should be extinguished using large amounts of water (min 2,650 gallons) to cool the high voltage battery. Fire fighters should not hesitate to pour larger amounts of water on the vehicle in such scenarios. Make sure the battery is fully cooled to avoid fire re-ignition.

### 6.3 How to deal with the situation

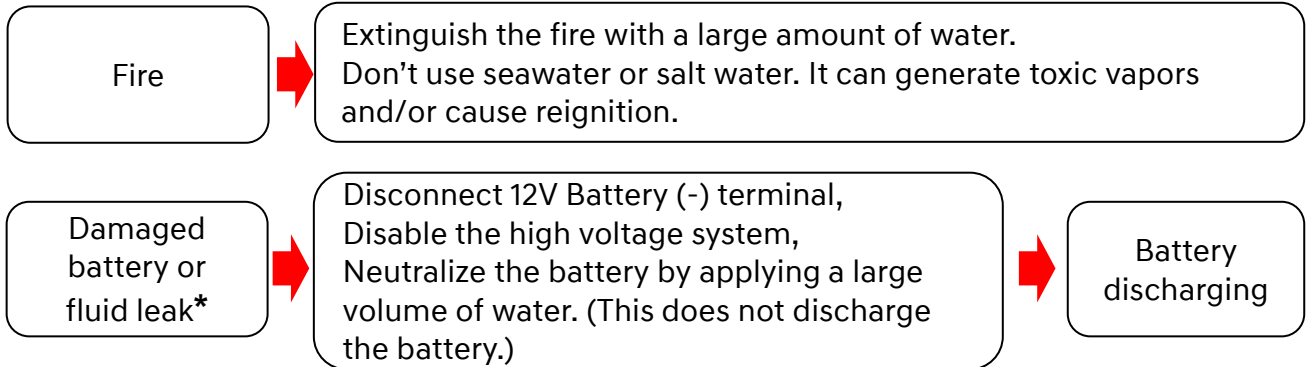

\*If electrolyte solution leakage, or any damage to the H.V battery casing is observed

#### 6.3.1 Vehicle fire

- Use a large volume of water (min 2,650 gallons). The water must cool down the battery.
- If water is put into the high voltage battery casing, it will be better to cool down the battery (But never attempt to penetrate the HV battery or its casing to apply water).



- Soaking the vehicle in the container filled with water can be an effective way to extinguish the fire.

### 6.3.2 High Voltage Battery Damage and Fluid Leaks

If electrolyte solution leakage, or any damage to the Lithium-ion battery casing is observed, the first responders should attempt to neutralize the battery by applying a large volume of water to the battery pack while wearing appropriate Personal Protective Equipment (PPE). The neutralization process helps stabilize the thermal condition of the battery pack but does not discharge the battery.

- Do not put any smoke, spark, or flame around the vehicle.
- Do not touch or step on any spilled electrolyte solution.
- If an electrolyte leak occurs, wear appropriate solvent resistant PPE and use soil, sand or a dry cloth to clean up the spilled electrolyte. Be sure to adequately ventilate the area.

#### **WARNING** Electrolyte Irritation

The high voltage battery contains electrolyte solution. To avoid exposure to electrolyte solution and serious personal injury, always wear appropriate solvent resistant PPE (Personal Protective Equipment) and SCBA (Self-Contained Breathing Apparatus).

- Electrolyte solution is an eye irritant – In the event of contact with eyes, rinse with plenty of water for 15 minutes.
- Electrolyte solution is a skin irritant. In the event of contact with skin, wash off with soap.
- Electrolyte liquid or fumes in contact with water will create vapors in the air from oxidization. These vapors may irritate the skin and eyes. In the event of contact with vapors, rinse with plenty of water and consult a doctor immediately.
- Electrolyte fumes (when inhaled) can cause respiratory irritation and acute intoxication. Inhale fresh air and wash mouth with water. Consult a doctor immediately.

### 6.4 High Voltage Battery re-ignition by stranded energy

Damaged cells in the high voltage battery can experience thermal runaway\* and reignite.

To prevent reignition, the first and second responders need to be aware of the risk of stranded energy\*\* which remains in the damaged cells and lead to reignition.

\*Thermal runaway : The originating cause of thermal runaway is generally short-circuiting inside a battery cell and a resultant increase in the cell's internal temperature.

The battery produces heat with thermal runaway and it can spread from one battery cell to many other cells, in a domino effect.

\*Stranded energy : Energy that remains inside any undamaged battery cells after the accident. That stranded energy can cause a high voltage battery to reignite multiple times after initial fire extinguishing efforts.

#### How to prevent reignition (Mitigating stranded energy risk)

Use a thermal imaging camera to ensure the high voltage battery is completely cooled before leaving the incident.

Always advise second responders that there is a risk of the battery re-igniting.

1. Disconnect the 12V battery (-) terminal (To depower battery management system)
2. Disable the high voltage system  
-refer to page 5-8
3. Discharge the high voltage battery  
-refer to page 21-22

### 7.1 Submerged or Partially Submerged Vehicles

Some emergency responses can involve a submerged vehicle. An Electrified G80 that is submerged does not have high-voltage components on the vehicle's body or framework. It is safe to touch the vehicle's body or framework if there is no severe damage to the vehicle, whether it is in water or on land.

In the event of a submerged, or partially submerged, vehicle, remove the vehicle from the water before attempting to disable it. Drain the water from the vehicle. Use one of the methods described in page 5-8 to disable the vehicle.

Then, discharge the battery by referring to page 21-22.

#### **WARNING**

- If severe damage causes high voltage components to become exposed, responders should take appropriate precautions and wear appropriate insulated personal protective equipment.
- Do not attempt to remove a safety plug while the vehicle is in water.

Failure to follow these instructions can lead to death or serious injury by electrocution.

### 8.1 Towing and Transportation

In the event of an accident, the high voltage system must be disabled. The cut-off switch must be disconnected from the high voltage battery according to one of the methods described in page 5-8 to disable the vehicle.

Towing the Electrified G80 is not different from towing a conventional electric vehicle. If emergency towing is necessary, we recommend having it done by an authorized Hyundai dealer or a commercial tow-truck service. Proper lifting and towing procedures are necessary to prevent damage to the vehicle. The use of wheel dollies or flatbed is recommended.

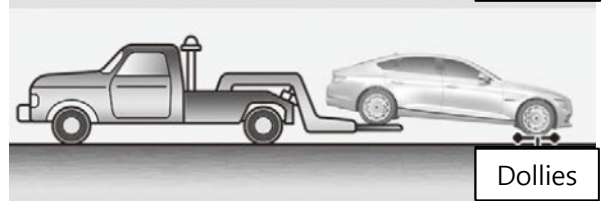
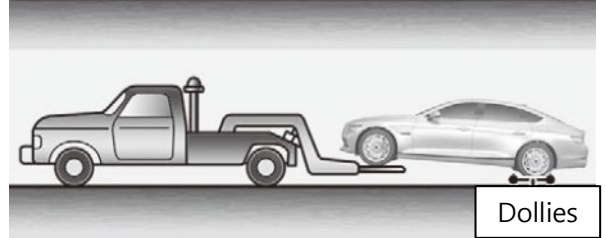
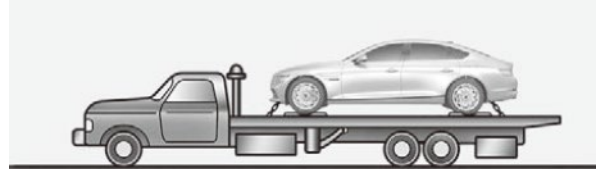

#### **CAUTION**

- Do not tow with sling-type equipment. Use a wheel lift or flatbed equipment.
- Never tow the vehicle with the front wheels on the ground (forward or backward), as this may cause fire or damage to the motor.
- If side airbags are equipped, make sure to turn off the ignition and tow it. If the vehicle is towed while the ignition is on, airbags may be deployed.

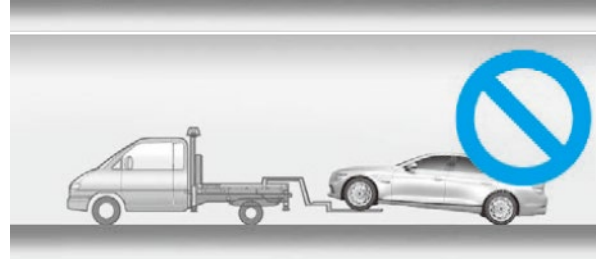

### 8.2 Storage of damaged vehicle with the damaged battery

- Drain the fluids and water inside the battery or vehicle, then disconnect the negative (-) terminal of the 12V battery and Cut-Off switch before storing a damaged vehicle.
  - Place the vehicle in an open space away from any structure, vehicle or building.
  - Then, keep on eye on the vehicle until the discharging procedures are completed.
  - If the battery can be removed from the vehicle by moving the vehicle onto a lift, remove and discharge the battery.
  - If the battery can't be removed, place the vehicle into a sufficiently large container and add water until the entire battery is submerged.
  - Add enough salt to the water container to create a 2% saltwater solution.
  - Leave the battery submerged in the saltwater solution for 3 days.
  - Then, drain the water by using **BMS cover (A)** and dry it.
  - If the high voltage battery cannot be removed AND the vehicle cannot be submerged, then store the vehicle with a waterproof cover.
- ※ Waterproof cover : size/material that can prevent water from entering the battery



**Battery discharging**

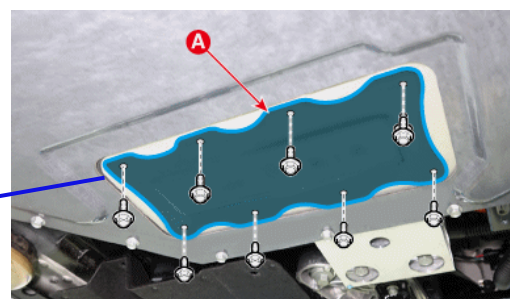
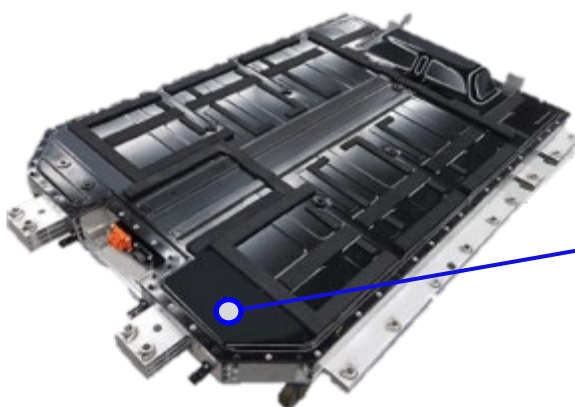

**A : BMS ECU service cover**

### 8.3 Battery Discharge/Storage

- To store the damaged battery safely, the battery must be discharged.
- If the battery can be removed from the vehicle, discharge the battery to prevent re-ignition.
- Place the battery into a sufficiently large container and add water until the battery is completely submerged.
- Add enough salt to the water container to create a 2% saltwater solution.
- Leave the battery submerged in the saltwater solution for 3 days.
- Remove the battery from the saltwater solution and dry it.

#### **⚠ WARNING**

- Extinguish all smoke, sparks, and flames around the vehicle.
- Electrolyte solution is a skin irritant.
- Do not touch or step on the spilled electrolyte solution.
- If an electrolyte leak occurs, wear appropriate solvent resistant PPE and use soil, sand, or a dry cloth to clean up the spilled electrolyte. Be sure to adequately ventilate the area.

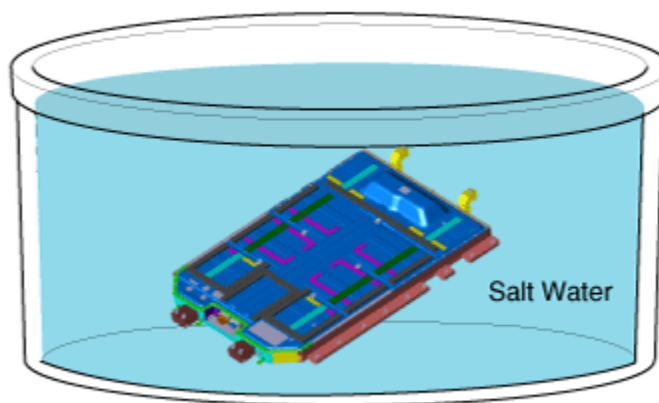



### 9.1 Emergency Starting

#### Jump Starting

1. Position the vehicles close enough that the jumper cables will reach, but do not allow the vehicle body parts to contact.
2. Avoid any moving parts in the PE room.
3. Turn off all unnecessary electrical loads.

4. First connect one end of a jumper cable to the positive(+) (1)terminal of the discharged battery in the PE room, then connect the other end to the positive(+) (2)terminal on the booster battery.

Proceed to connect one end of the other jumper cable to the negative(-) (3)terminal of the booster battery, then the other end to a solid, stationary, metallic point (4).

5. Start the vehicle with the booster battery, then start the vehicle with the discharged battery.
6. After a few minutes, turn off the both vehicles.
7. Remove the negative terminal cable first and then remove the positive terminal cable.

If the cause of your battery discharging is not apparent, we recommend that the system be checked by an authorized GENESIS dealer.

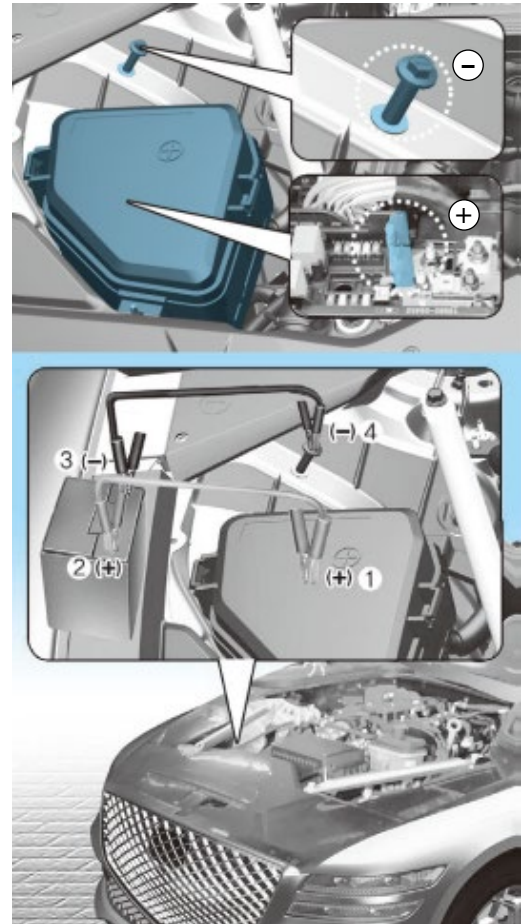

#### **CAUTION**

- Do not attempt to jump start the high voltage battery.
- Do not connect the cables to or near any part that moves when the vehicle is started.
- Do not allow the jumper cables to contact anything except the correct battery terminals or the correct ground.
- Do not lean over the battery when making connections.

### 9.2 Airbag system ( SRS: Supplemental Restraint System)

#### Airbag

6 airbags are installed in the G80 electrified, located in the areas shown in the image below. Before performing any emergency procedure, make sure the vehicle ignition switch is turned off and disconnect the negative connector from the 12V auxiliary battery (refer to page 6) to prevent accidental deployment of undeployed airbags.

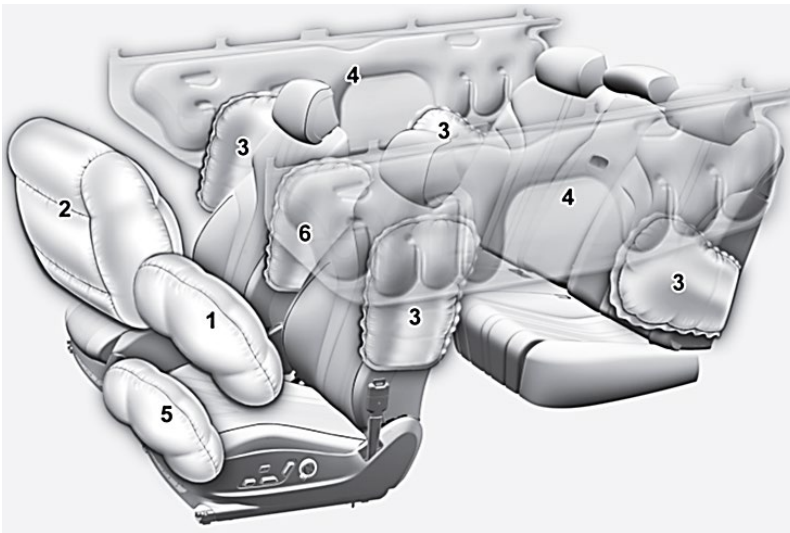

- (1) Driver's front airbag
- (2) Passenger's front airbag
- (3) Side airbag
- (4) Curtain airbag
- (5) Driver's knee airbag
- (6) Front center airbag

\* The actual air bags and seats in the vehicle may differ from the illustration.

#### Seat Belt Pretensioner

In the G80 electrified, the Front and Rear seat belts are equipped with pretensioners. When the seat belt pretensioners are activated in a collision, a loud noise may be heard and fine dust, which may appear to be smoke, may be visible in the passenger compartment. These are normal operating conditions and are not hazardous. The seat belt pretensioner assembly mechanisms may become hot during activation and may need several minutes to cool down after they have been activated.

### 9.2 Airbag system ( SRS: Supplemental Restraint System)

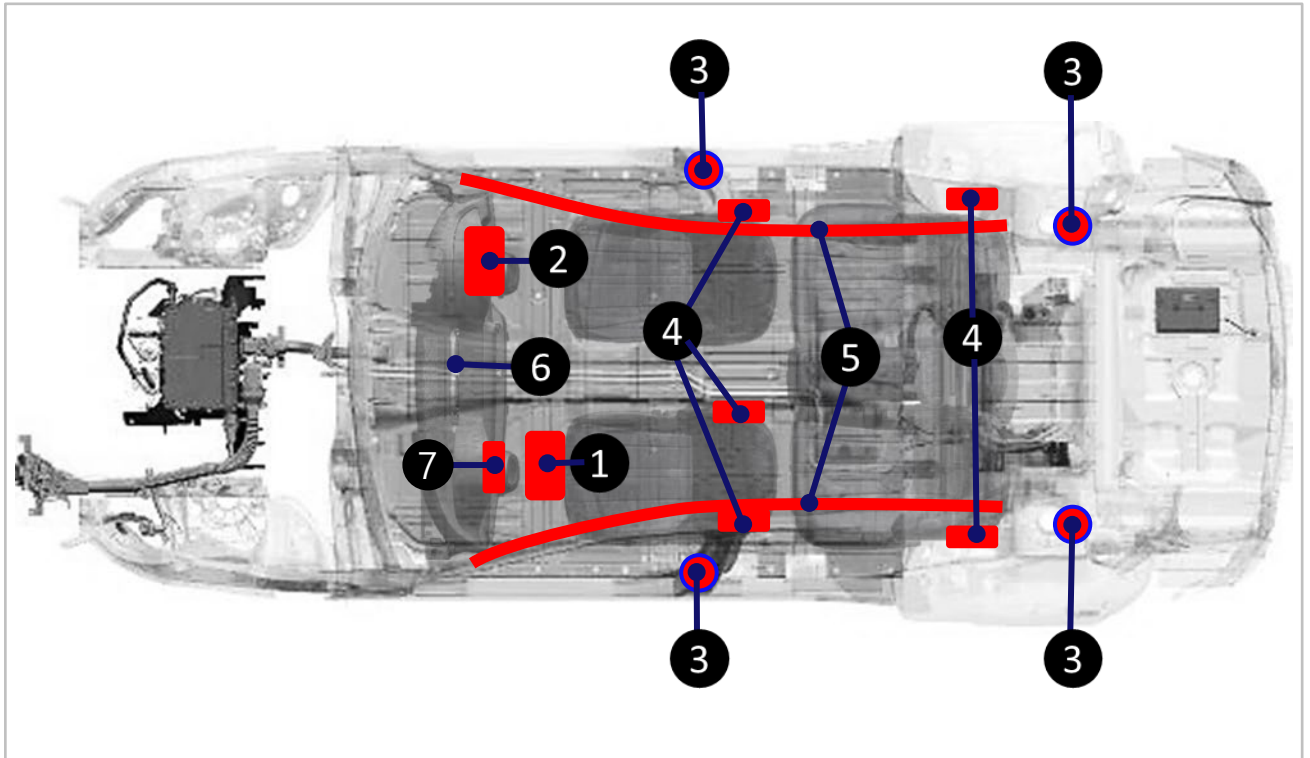

- |  |  |
|--|--|
| 1. Driver's front airbag                   | 2. Passenger's front airbag                |
| 3. Seat Belt Pretensioner (BPT)            | 4. Side Airbag (Driver, Passenger, Center) |
| 5. Curtain Airbag (Driver, Passenger side) | 6. Airbag control module (SRSCM)           |
| 7. Driver's knee airbag                    |  |

#### **⚠ WARNING**

To avoid injuries caused by accidental deployment of airbags:

- Do not cut the airbag system shown in the image(s) above.
- Make sure the vehicle ignition switch is turned off, disconnect the negative cable from the 12V auxiliary battery (located in the left side of motor room) and wait 3 minutes or longer to allow the system to deactivate.

Failure to follow any of these instructions may result in serious injury or death from accidental deployment of the airbag system.

### 9.2 Airbag system ( SRS: Supplemental Restraint System)

#### Seatbelt system

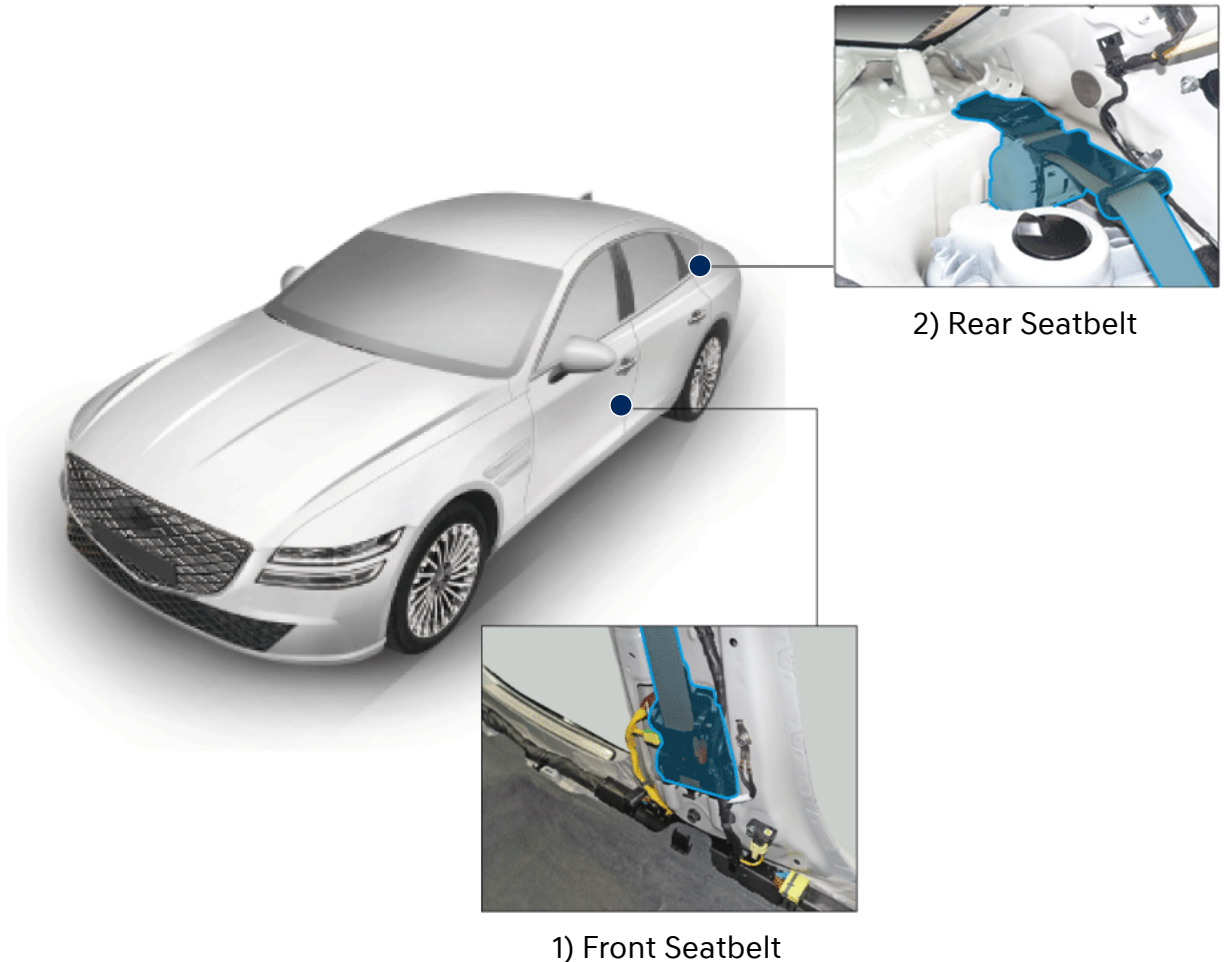

#### **⚠ WARNING**

To avoid injuries caused by accidental deployment of undeployed airbags

- Do not cut the airbag system shown in the image(s) above.
- Make sure the vehicle ignition switch is turned off, disconnect the negative cable from the 12V auxiliary battery (located in the left side of motor room) and wait 3 minutes or longer to allow the system to deactivate.

Failure to follow any of these instructions may result in serious injury or death from accidental deployment of the airbag system.

